

# SUPER LINE UP ASSEMBLY INSTRUCTIONS

## PG. 1

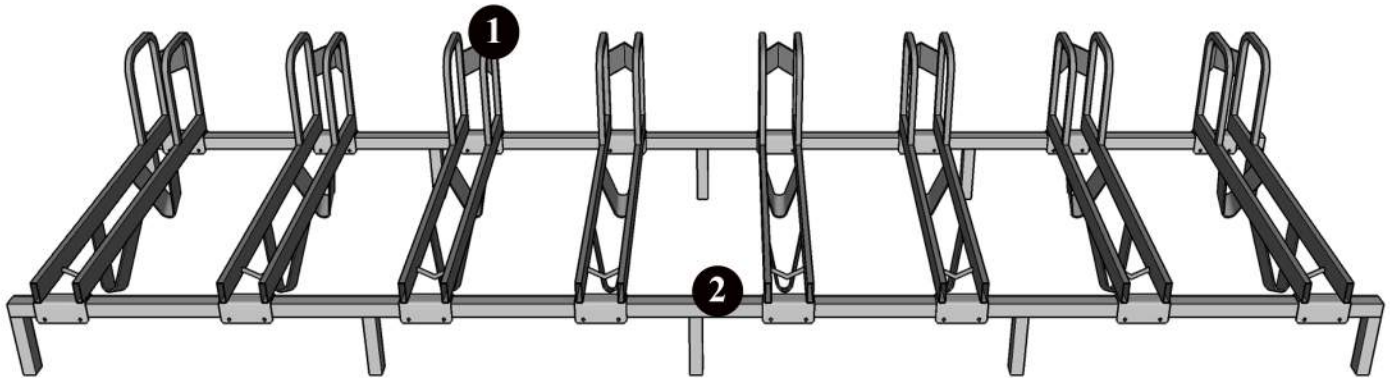

1.

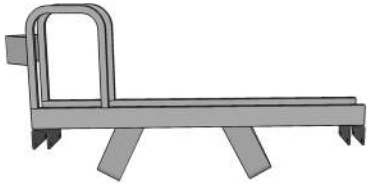

STANCHION

2.



RAIL

### HARDWARE:

1/4" X 1 1/2" BOLTS

1" BLACK PLUGS

1/4" STOPNUTS

1/2" X 1 1/2" BLACK PLUGS

### STEP 1.

Locate the two Rails. Place them upside down on the floor and insert the 1" black plugs into the feet, as shown in Diagram 1.

\*The number of feet will vary based on the size of the rack.

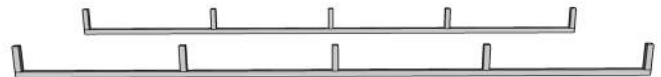

### STEP 2

Flip the rails and stand them on their feet. Place the rails about 26" apart, as shown in Diagram 2. Use a Stanchion as a guide.

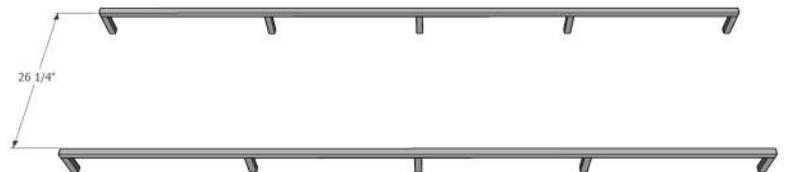

### STEP 3

Now take a Stanchion and insert the 1/2" X 1 1/2" Plugs into the front and back of each. Slide the front of the stanchion over the Rail, as shown in Diagram 3.

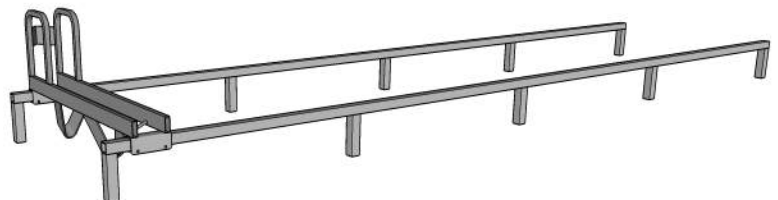

# SUPER LINE UP ASSEMBLY INSTRUCTIONS

## PG. 2

### STEP 4

Add the remaining Stanchins by repeating Step 3. Once they are spaced as desired, secure into place using the 1/4" x 1 3/4" Bolts and 1/4" Stopnuts.

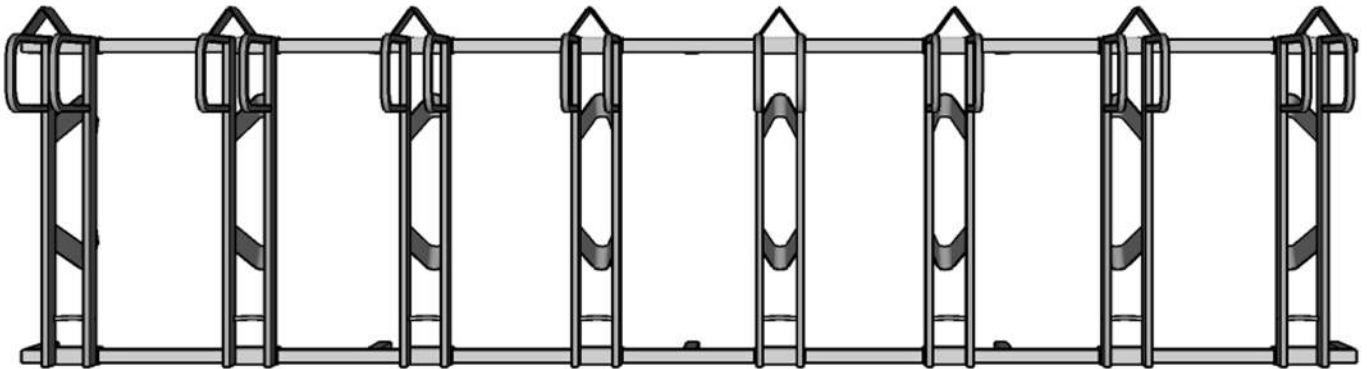

\*WALL FORMAT VERSION 6-bike SPACING: 9" between stanchions  
7-bike SPACING: 9 1/2" between stanchions  
8-bike SPACING: 10 1/2" between stanchions

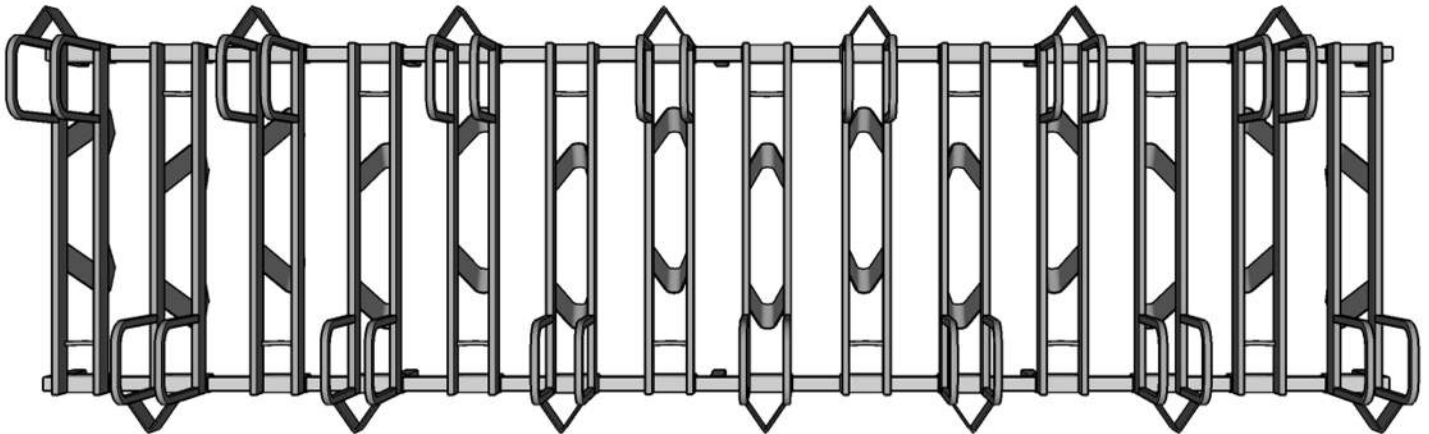

\*ISLAND FORMAT VERSION 10-bike SPACING: 3 1/2" between stanchions  
12-bike SPACING: 3 1/4" between stanchions  
14-bike SPACING: 3 3/4" between stanchions